

HOISTWAY PLAN

2000# [905 KG] CAPACITY – MEETS A.D.A. REQUIREMENTS
 DIMENSIONS ARE BASED ON UP TO 80'-0" [24384] OF TRAVEL, CAR SPEED
 UP TO 150 FPM, STANDARD 5'-0" [1524] PIT, & 12'-6" [3810] OVERHEAD.

OTHER DOOR ARRANGEMENTS AVAILABLE (LEFT HAND SHOWN AT
 FRONT AND RIGHT HAND AT SIDE).
 OTHER PLATFORM SIZES, CAPACITIES, & HIGHER TRAVEL AVAILABLE (CONSULT FACTORY).

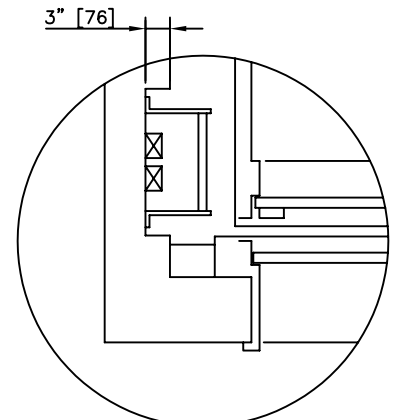

HOISTWAY NOTCH FOR
 PIT LADDER – 2002 CODE

CEMCO LIFT

ELEVATOR SYSTEMS

2801 TOWNSHIP LINE ROAD, HATFIELD, PA 19440
 215-799-2900 • 1-800-962-3626 • FAX: 215-703-0347

NOTES:

- 1) DIMENSIONS IN [] ARE METRIC.
- 2) ALL DIMENSIONS ARE SUBJECT TO CHANGE WITHOUT NOTICE. CONFIRM WITH FACTORY.
- 3) ** 11" MINIMUM WITH 2002 AND ABOVE CODE AND NO NOTCHING