

HOISTWAY PLAN

3500# [1588 KG] CAPACITY – MEETS A.D.A. REQUIREMENTS
 DIMENSIONS ARE BASED ON UP TO 12'-6" [3810] OF TRAVEL, CAR SPEED UP TO 100 FPM, STANDARD 4'-0" [1219] PIT, & 12'-6" [3810] OVERHEAD.

LEFT, RIGHT, AND CENTER OPEN DOORS AVAILABLE (LEFT HAND SHOWN).
 OTHER PLATFORM SIZES, CAPACITIES, & HIGHER TRAVEL AVAILABLE (CONSULT FACTORY).

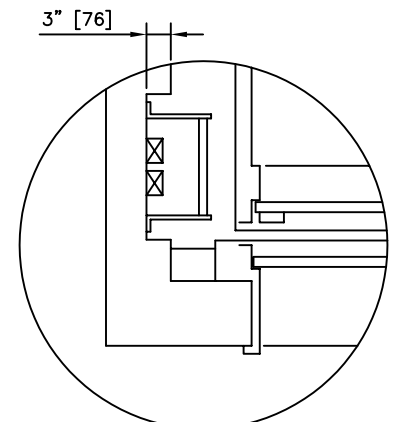

HOISTWAY NOTCH FOR PIT LADDER – 2002 CODE

NOTES:

- 1) DIMENSIONS IN [] ARE METRIC.
- 2) ALL DIMENSIONS ARE SUBJECT TO CHANGE WITHOUT NOTICE. CONFIRM WITH FACTORY.
- 3) ** 11" MINIMUM WITH 2002 AND ABOVE CODE AND NO NOTCHING

CEMCO LIFT
 ELEVATOR SYSTEMS

2801 TOWNSHIP LINE ROAD, HATFIELD, PA 19440
 215-799-2900 • 1-800-962-3626 • FAX: 215-703-0347